

## Features

- 95W Peak Pulse Power Per Line(8/20us)
- 5V Working Peak Reverse Voltage
- Maximum Reverse Peak Pulse Current:4.5A
- ESD per IEC 61000-4-2(Contact):25KV
- ESD per IEC 61000-4-2(Air):27KV
- Clamping Voltage @IPP=1A:9.5V
- Junction Capacitance:1PF
- Package:DFN1006-2L(0402)
- Polarity: Bidirectional

## Mechanical Characteristics

- Mechanical Characteristics
- Lead Finish: NiPdAu
- Case Material: “ Green ” Molding Compound.
- UL Flammability Classification Rating 94V-0
- Moisture Sensitivity: Level 3 per J-STD-020
- Terminal Connections: See Diagram Below
- Marking Information: See Below

## Schematic And Configuration

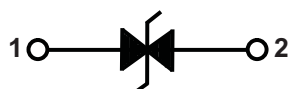

## Ordering Information

Part Number	Packaging	Reel Size
TEVB1R0V05B1X	Tape & Reel	7inch

## Absolute Maximum Ratings (Ta=25°C, RH=45%-75%, unless otherwise noted)

Parameter	Symbol	Value	Unit
Operating Temperature Range	Tj	-55~+125	
Storage Temperature Range	Tstg	-55~+150	

## Electrical Characteristics (Ta=25°C)

Parameter	Symbol	Min	Type	Max	Unit	Test Condition
Reverse Working Voltage	Vrwm			5	V	
Breakdown Voltage	Vbr	7.7			V	It=1mA
Reverse Leakage Current	Ir			0.1	uA	Vrwm=5V
Clamping Voltage	Vc		9.5	10	V	Ipp=1A(8 × 20us pulse)
Juntion Capacitance	Cj	0.5	1	2.3	pF	Vr=0V,f=1MHz

Typical Performance Characteristics (Ta=25 , unless otherwise noted)

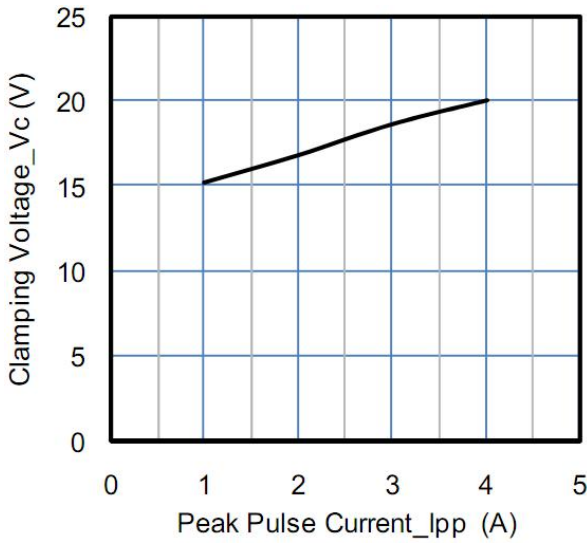

Clamping Voltage vs. Peak Pulse Current

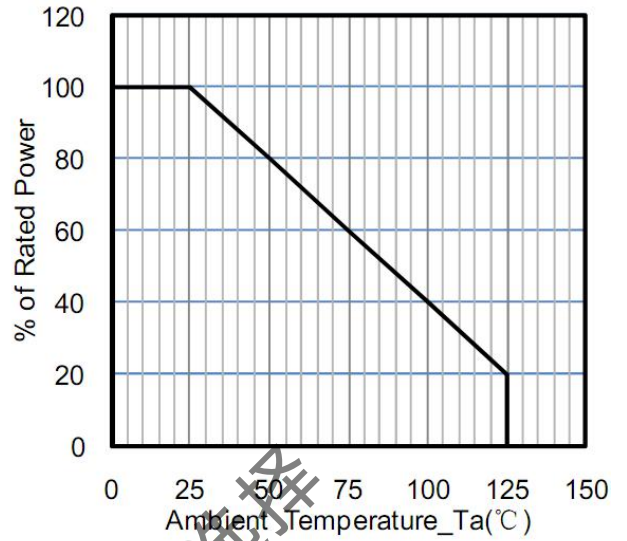

Power Derating Curve

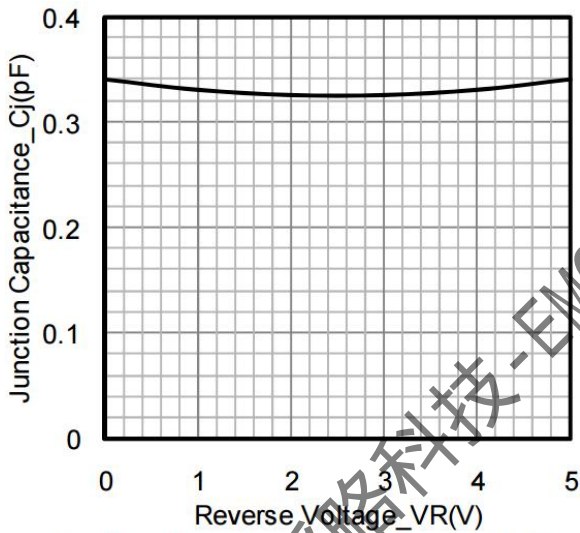

Junction Capacitance vs. Reverse Voltage

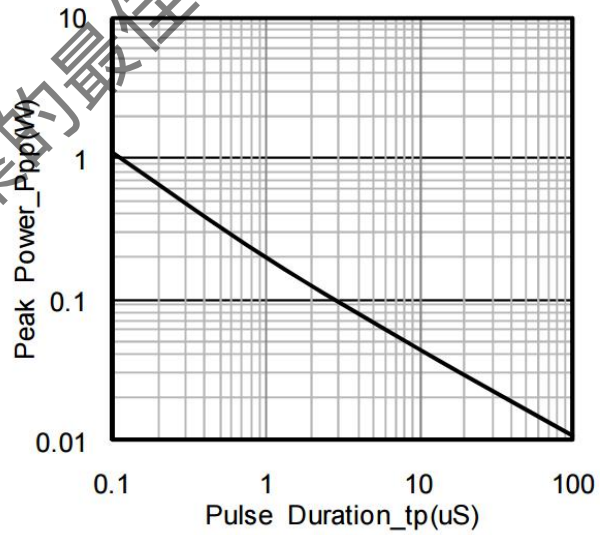

Peak Pulse Power vs. Pulse Time

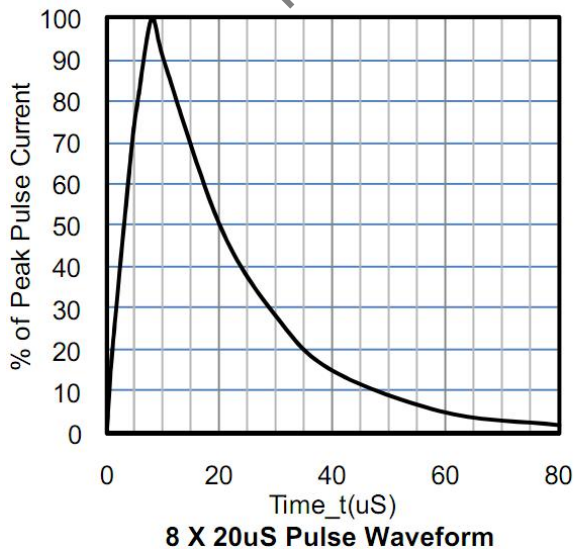

8 X 20uS Pulse Waveform

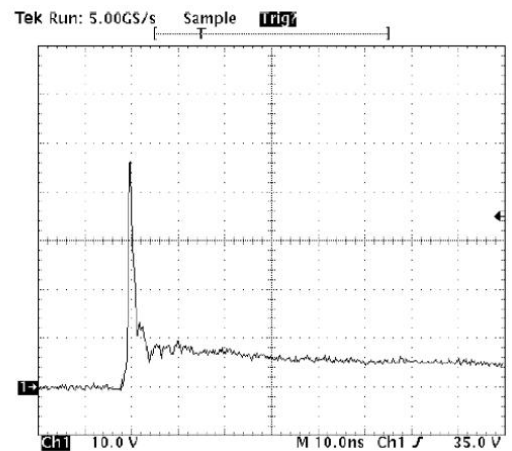

ESD Clamping Voltage

8 kV Contact per IEC61000-4-2

Soldering Parameters

Reflow Condition		Pb-Free Assembly (see as bellow)
Pre Heat	-Temperature Min ( $T_{s(min)}$ )	+150°C
	-Temperature Max( $T_{s(max)}$ )	+200°C
	-Time (Min to Max) (ts)	60-180 secs.
Average ramp up rate (Liquid us Temp ( $T_L$ ) to peak)		3°C/sec. Max
$T_{s(max)}$ to $T_L$ - Ramp-up Rate		3°C/sec. Max
Reflow	-Temperature( $T_L$ ) (Liquid us)	+217°C
	-Temperature( $t_L$ )	60-150 secs.
Peak Temp ( $T_P$ )		+260(+0/-5)°C
Time within 5°C of actual Peak Temp ( $t_p$ )		30 secs. Max
Ramp-down Rate		6°C/sec. Max
Time 25°C to Peak Temp ( $T_P$ )		8 min. Max
Do not exceed		+260°C

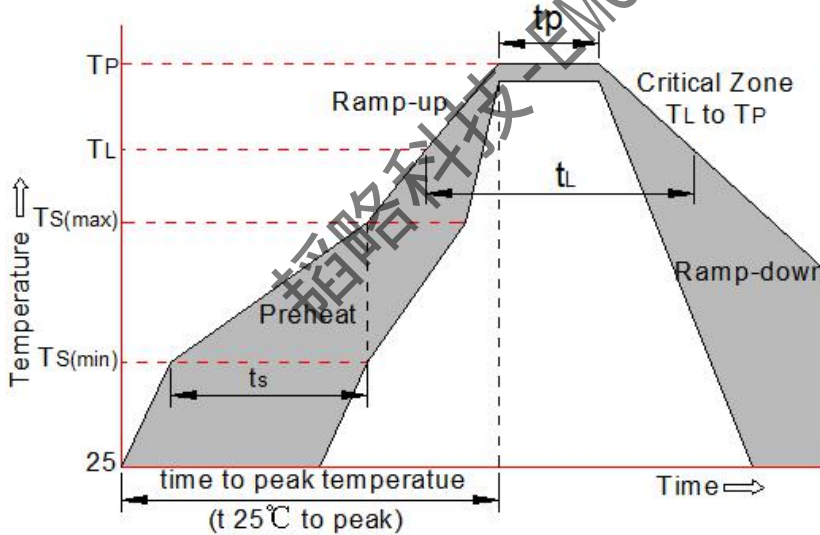

## Package Mechanical Data

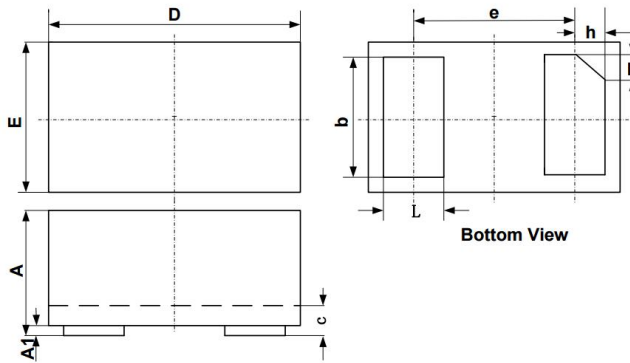

SYM	DIMENSIONS					
	MILLIMETERS			INCHES		
	MIN	NOM	MAX	MIN	NOM	MAX
A	0.45	0.50	0.55	0.018	0.020	0.022
A1	0.00	0.02	0.05	0.000	0.001	0.002
b	0.45	0.50	0.55	0.018	0.020	0.022
c	0.12	0.15	0.18	0.005	0.006	0.007
D	0.95	1.00	1.05	0.037	0.039	0.041
e	0.65 BSC			0.026 BSC		
E	0.55	0.60	0.65	0.022	0.024	0.026
L	0.20	0.25	0.30	0.008	0.010	0.012
h	0.07	0.12	0.17	0.003	0.005	0.007

## Suggested Land Pattern

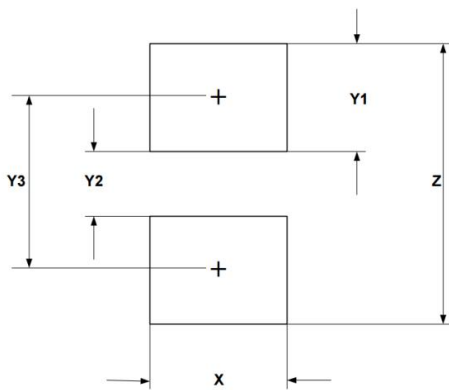

SYM	DIMENSIONS	
	MILLIMETERS	INCHES
X	0.60	0.024
Y1	0.50	0.020
Y2	0.30	0.012
Y3	0.80	0.032
Z	1.30	0.052

## Contact Information

SHENZHEN TOP-FLIGHT TECHNOLOGY CO.,LTD

4th Floor, C Building, Quansen Industrial Park , Bulong Road, Longhua New District, Shenzhen

Tel: 86-755-82908191 Fax: 86-755-82908701 Email: kang@topleve.com

Website: <http://www.topleve.com>