

TESB3R0V05B1X

ESD SUPPRESSOR

TOP-EMC

Features

- SMD type zinc oxide based ceramic chip
- Lead free plating termination provided good solderability characteristic
- Insulator over coat keeps excellent low and stable leakage current
- Quick response time (<1ns)
- Low clamping voltage
- High transient current capability
- Meet IEC 61000-4-2 standard
- Compact size for EIA 0402

Applications

- Application for Mother Board, Notebook, Cellular Phone, PDA, handheld device
- DSC,DV,Scanner , and Set-Top Box etc.
- Data port:Audio,Video,Keyboard,Charge etc.

Construction & Dimension

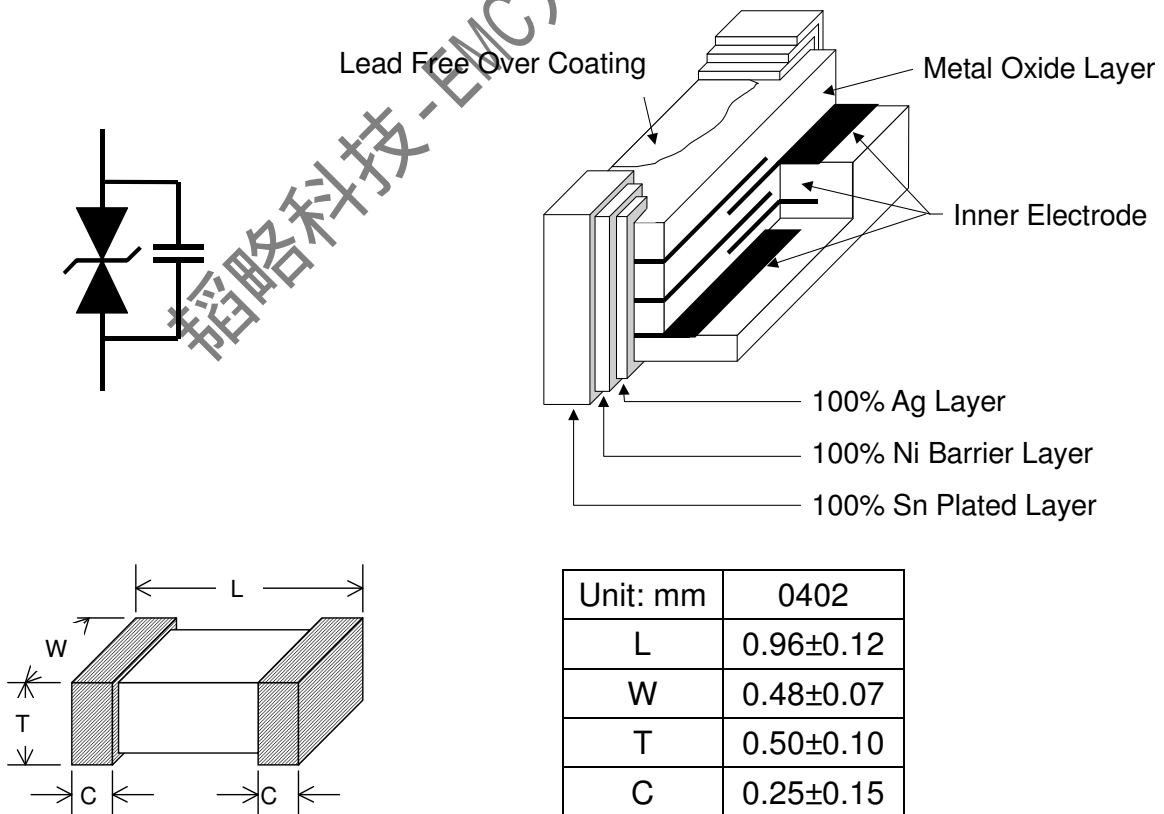

Part ratings and characteristics

	Working voltage		Varistor voltage	Clamping Voltage	Capacitance	Peak current	Transient energy
Symbol	V_{RMS}	V_{DC}	V_V	V_C	C_p	i_{max}	W_{max}
Units	Volts	Volts	Volts	Volts	pF	Amps	Joules
	(Max.)	(Max.)		(Max.)	(Typical)	(Max.)	(Max.)
Test Condition		$< 10 \mu A$	1mA DC	1A 8/20 μs	1MHz	8/20 μs	10/1000 μs
TESB3R0V05B1X	-	5	45 ~ 65	135	3	-	-

V_{RMS} – Maximum AC operating voltage the varistor can maintain and not exceed $10\mu A$ leakage current

V_{DC} – Maximum DC operating voltage the varistor can maintain and not exceed $10\mu A$ leakage current

V_V – Voltage across the device measured at 1mA DC current.
Equivalent to V_b , "Breakdown Voltage".

C_p – Device capacitance measured with zero volt bias $1V_{rms}$ at 1MHz.

V_C – Maximum peak voltage across the varistor measured at 8/20 μs waveform and 1A pulse current

i_{max} – Maximum peak current which may be applied with 8/20 μs waveform without device failure

W_{max} – Maximum energy that may be dissipated with the 10/1000 μs waveform without device failure.

General electrical specifications

General technical data

Operating temperature	-40 ... +125°C
Storage temperature (on board)	-40... +125°C
Response time	<1 ns
Solderability	245±5°C, 3 ±1sec
Solder leach resistance	260±5°C, 10 ±1sec

Environmental Specifications

Characteristics	Specifications	Test condition
Bias humidity	$\Delta V_V / V_V \leq \pm 10\%$	90%RH, 40°C, Working voltage, 1000 hours
Thermal shock	$\Delta V_V / V_V \leq \pm 10\%$	-40°C to 85°C, 30 min. Cycle, 5 cycles
Full load voltage	$\Delta V_V / V_V \leq \pm 10\%$	Working voltage, 85°C, 1000 hours

Storage Condition with package

Storage Temperature: 5 to 40°C

Relative Humidity: to 65%

Storage Time: 12 months max

Taping Package and Label Marking

Carrier tape dimensions

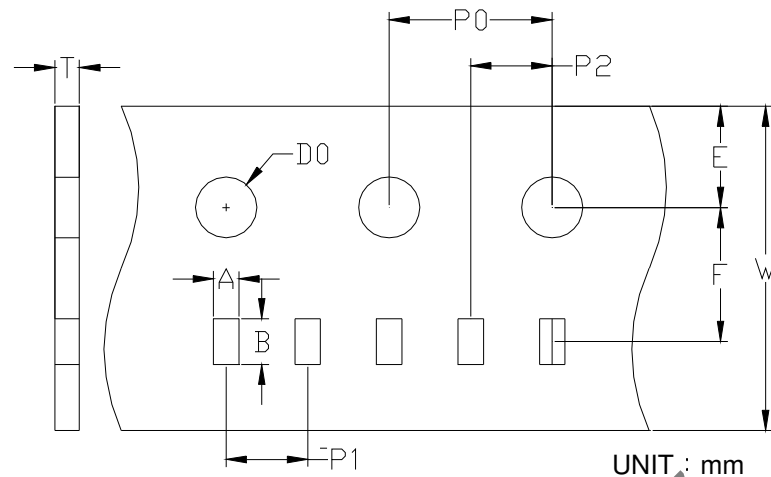

Type	A	B	W	E	F	P0	P1	P2	D0	T
0402	0.59 ±0.03	1.12 ±0.03	8.0 ±0.1	1.75 ±0.05	3.5 ±0.05	4.0 ±0.1	2.0 ±0.05	2.0 ±0.05	1.55 ±0.05	0.60 ±0.03

Taping reel dimensions

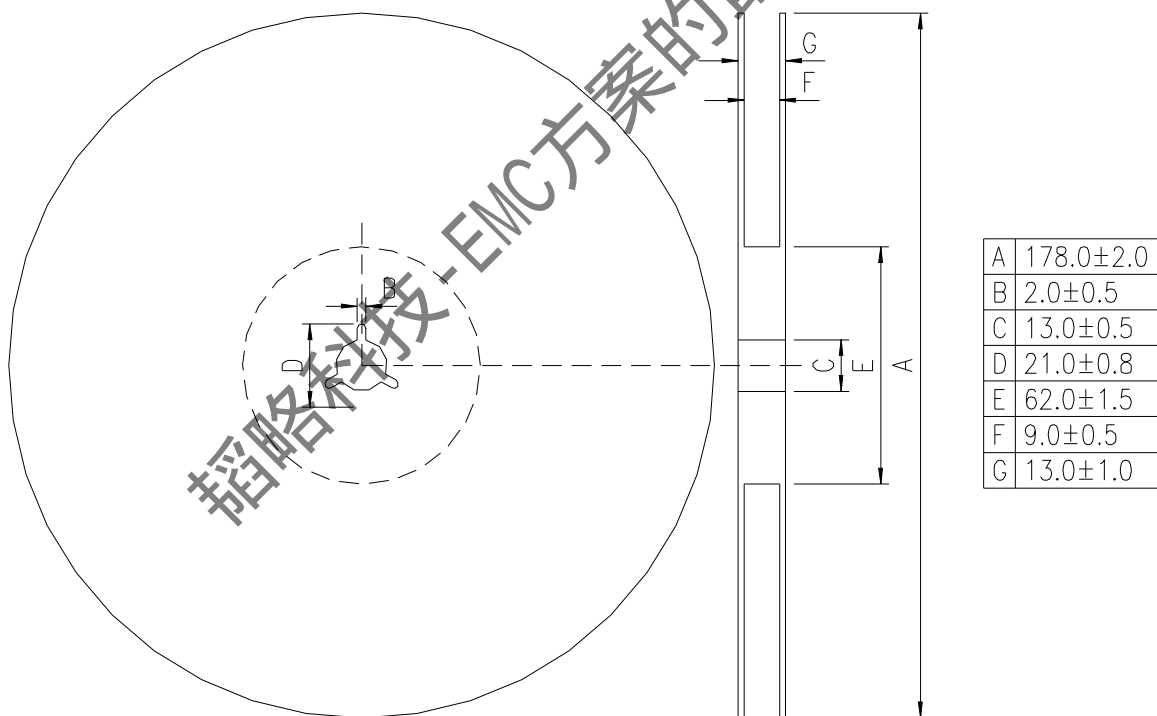

Taping specifications

There shall be the portion having no product in both the head and the end of taping, and there shall be the cover tape in the head of taping.

Quantity of products in the taping package

- (1) Standard quantity : 10,000pcs/Reel for MLVS 0402 Lead Free Series
- (2) Shipping quantity is a multiple of standard quantity.

Precautions for Handling

Solder cream in reflow soldering

Refer to the recommendable land pattern as printing mask pattern for solder cream.

- (1) Print solder in a thickness of 150 to 200 μm .
- (2) Dimensions: millimeters (inches)

0402

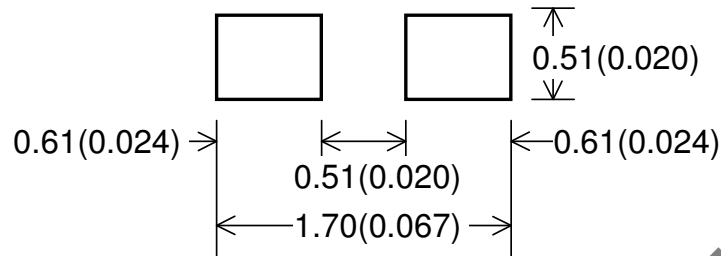

Precaution for handling of substrate

Do not exceed to bend the board after soldering this product extremely.

(Reference examples)

- Mounting place must be as far as possible from the position, which is close to the break line of board, or on the line of large holes of board.
- Do not bend extremely the board, in mounting another component.
If necessary, use back-up pin (support pin) to prevent from bending extremely.
- Do not break the board by hand. We recommend using the machine or the jig to break it.

Precaution for soldering

Note that rapid heating, rapid cooling or local heating will easily damage this product.

Do not give heat shock over 100°C in the process of soldering. We recommend taking preheating and gradual cooling.

Recommendable reflow soldering

*According to J-STD-020C

Profile Feature	Pb-Free Assembly
Average Ramp-Up Rate (T _{smax} to T _p)	3° C/second max.
Preheat – Temperature Min (T _{smin}) – Temperature Max (T _{smax}) – Time (t _{smin} to t _{smax})	150°C 200°C 60-180 seconds
Time maintained above: – Temperature (T _L) – Time (t _L)	217°C 60-150 seconds
Peak/Classification Temperature (T _p)	260°C
Time within 5 °C of actual Peak Temperature (t _p)	20-40 seconds
Ramp-Down Rate	6°C/second max.
Time 25 °C to Peak Temperature	8 minutes max.

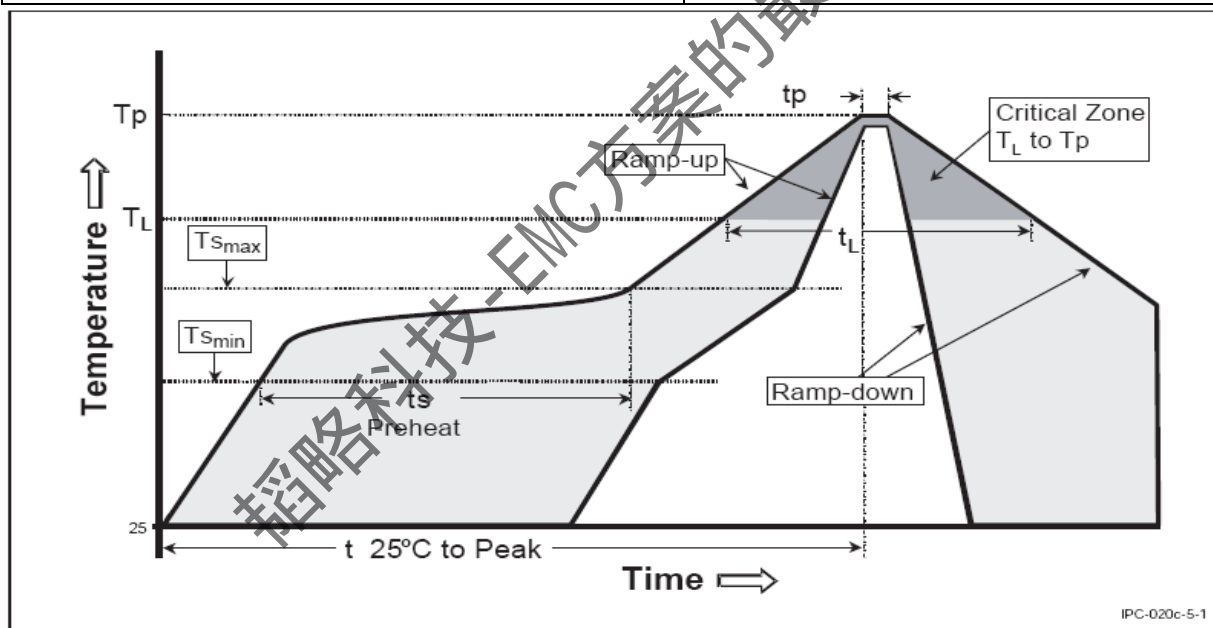

Soldering gun procedure

Note the follows, in case of using solder gun for replacement.

- (1) The tip temperature must be less than 350°C for the period within 3 seconds by using soldering gun less than 30W.
- (2) The soldering gun tip shall not touch this product directly.

Soldering volume

Note that excess of soldering volume will easily get crack the body of this product.

Contant Information

SHENZHEN TOP-FLIGHT TECHNOLOGY CO.,LTD

4th Floor, C Building, Quansen Industrial Park , Bulong Road, Longhua New District, Shenzhen

Tel: 86-755-82908191 Fax: 86-755-82908701 Email: kang@topleve.com

Website: <http://www.topleve.com>